



# Putt & Play



Same Old Putting. A New Way Of Playing.



# It's Still Mini Golf, Just Better.

A putter, a ball, and a hole...a simple combination that has entertained millions for years. So let's not fix what ain't broke...let's just add some awesome!

**Putt & Play** offers the classic game of mini golf, complimented with state-of-the-art ball-tracking technology, as a fun, easy & pre-packaged enterprise. Some nifty features include automated scoring & leaderboard updates with shot trajectory animated playback that can even be sent to players after the game has ended.



# A Traditional Game Played In A Modern World.

With **Putt & Play** the skill, sociableness and unique playability of mini golf is not overshadowed by distracting gimmicks or dressed-up as alternate games.

Instead, it keeps the fun of mini golf by innovating more classic hole designs and adding some magic by integrating the latest ball-tracking technology so that each shot is tracked, counted and celebrated.

- ACCURATELY TRACK THE TRAJECTORY OF EVERY PUTT
- DISPLAY ACTION REPLAYS OF EACH PUTT
- AUTOMATED POINTS SCORING FOR EVERY PUTT, HAZARD, BOOSTER
- ENHANCE EACH HOLE WITH FUN ANIMATIONS BASED ON BALL MOVEMENTS
- LIVE LEADERBOARD UPDATES TO SPUR ON COMPETITION
- SEND PLAYERS HIGHLIGHT REELS OF EPIC HOLE IN ONES SHOTS AFTER A GAME
- KEEP TABS OF ANY ILLEGAL STROKES

# Sharing Is Caring

Our tech provides action replays of every shot! That means players can receive a video of their epic hole-in-one to enjoy & share with their followers long after the action on the course has ended!

[#thewinningputt](#) [#puttnplayallday](#)



# If It Happens On The Green, You'll See It On The Screen!

The **Putt & Play** system includes a full user interface suite that caters for customers from pre-booking a game online to the final leaderboard and more!

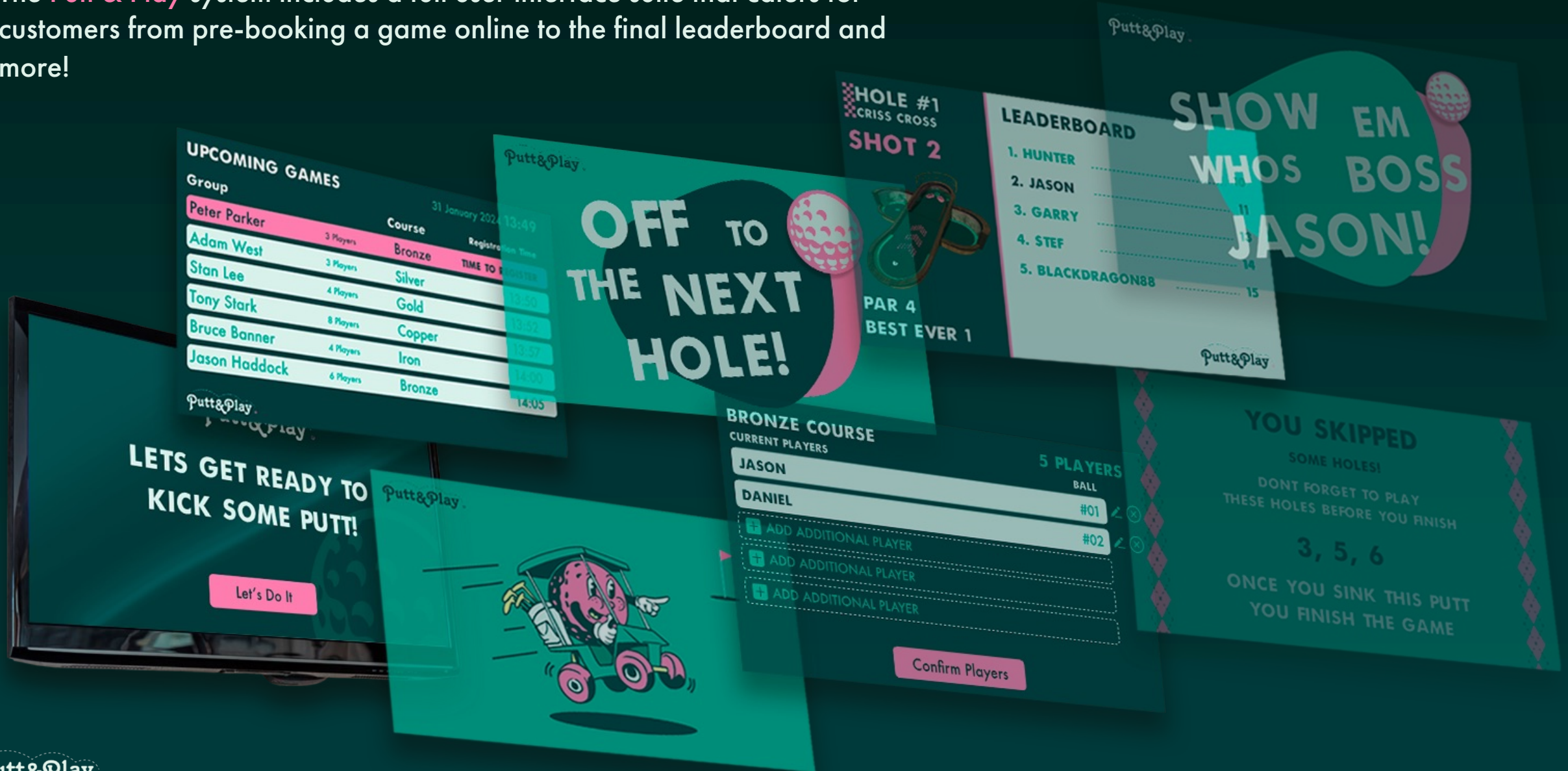

# The Process



As the old golf saying goes...different strokes for different folks, well, now there's different menus for different venues – so let our design team work along with you to make the best use of your available space and choose from a variety of classic hole designs.

STEP

1

Collaborate with the Putt & Play design team to assess your venue & order a selection of hole designs from our catalogue.

STEP

2

Once the designs are agreed upon, should they require customizing, our fabricators will start building your holes to meet your layout.

STEP

3

Our Putt & Play installers will come and install your course design at your site including hole setup, camera & screen placements and computer integration.

STEP

4

Once your holes are installed and your course is ready for the public, there will be operational support & direction to keep the Putt & Play system running optimally.



# Modular Holes



Each hole is designed & constructed in a pre-packaged, modular fashion that allows for **easy layout planning and installation**.

The ready-to-assemble nature of each hole means maintenance and repair can be carried out **quick and easy**.

And when it comes to branding and stylizing, each hole's decor can be **customized to suit your theme** or identity and be carried through to the accompanying software user interfaces.

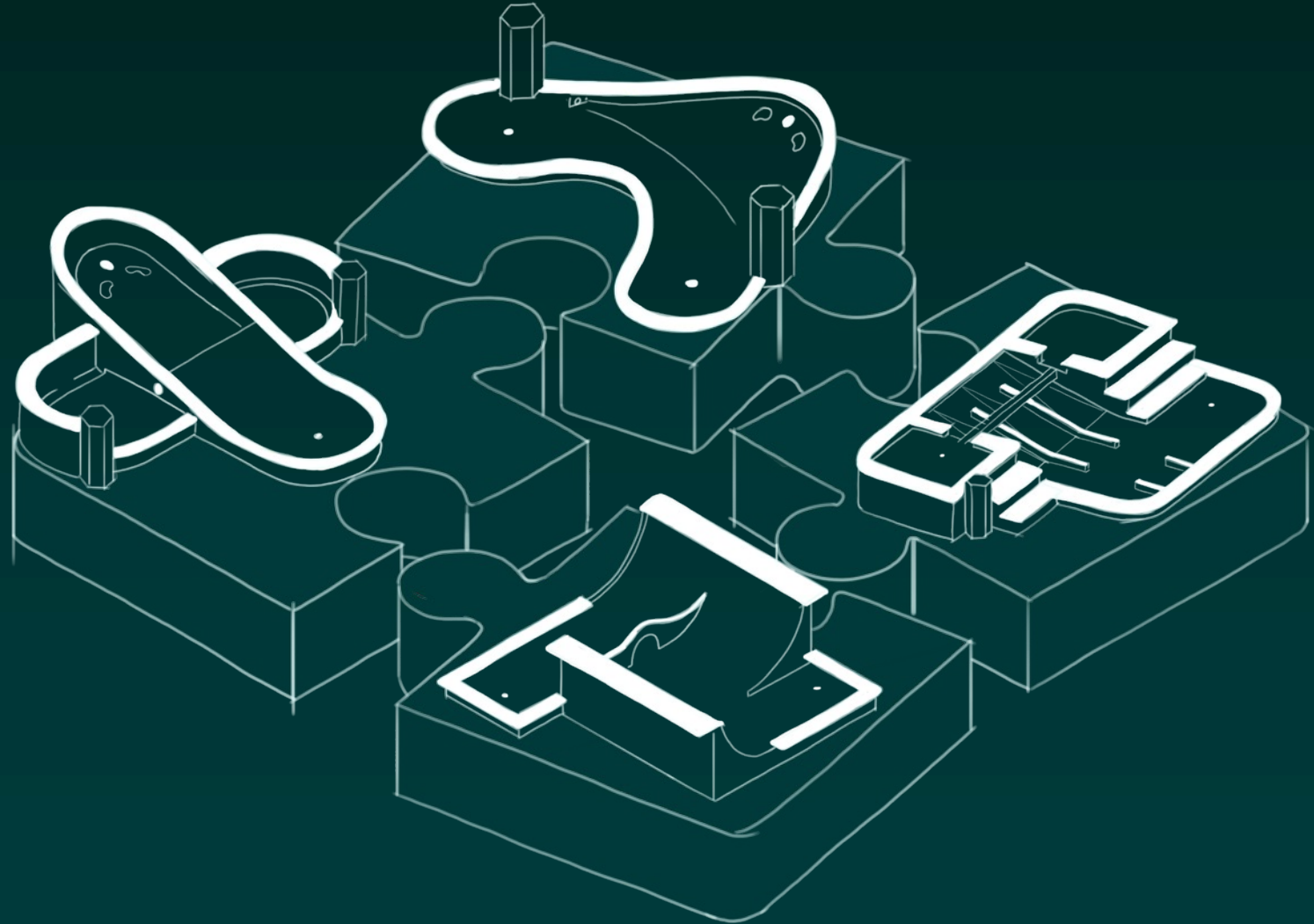



**AND NOW,  
SOME  
EXAMPLES OF OUR  
HOLE DESIGNS!**

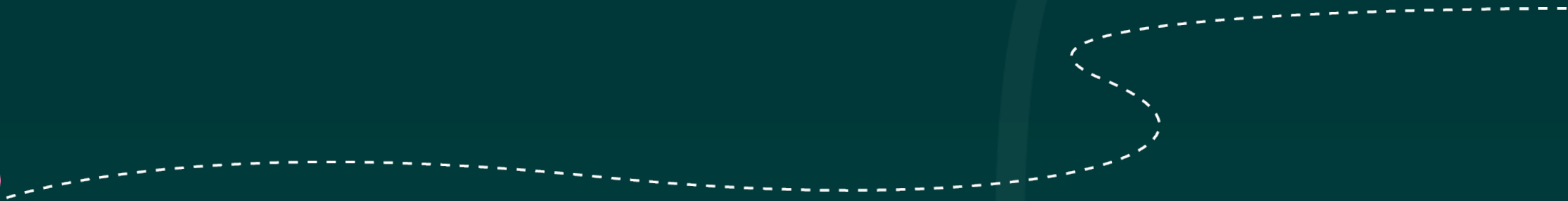



# CRISS-CROSS

Try your luck and ramp straight down the middle for a Booster fast-track and a hole-in-one! But be careful, the path is narrow with two hazard bunkers on either side. One of them leads your ball far from the hole and one of them takes you closer... but which one is which?

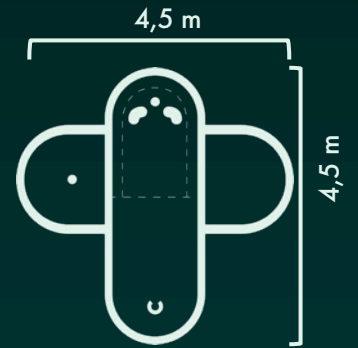
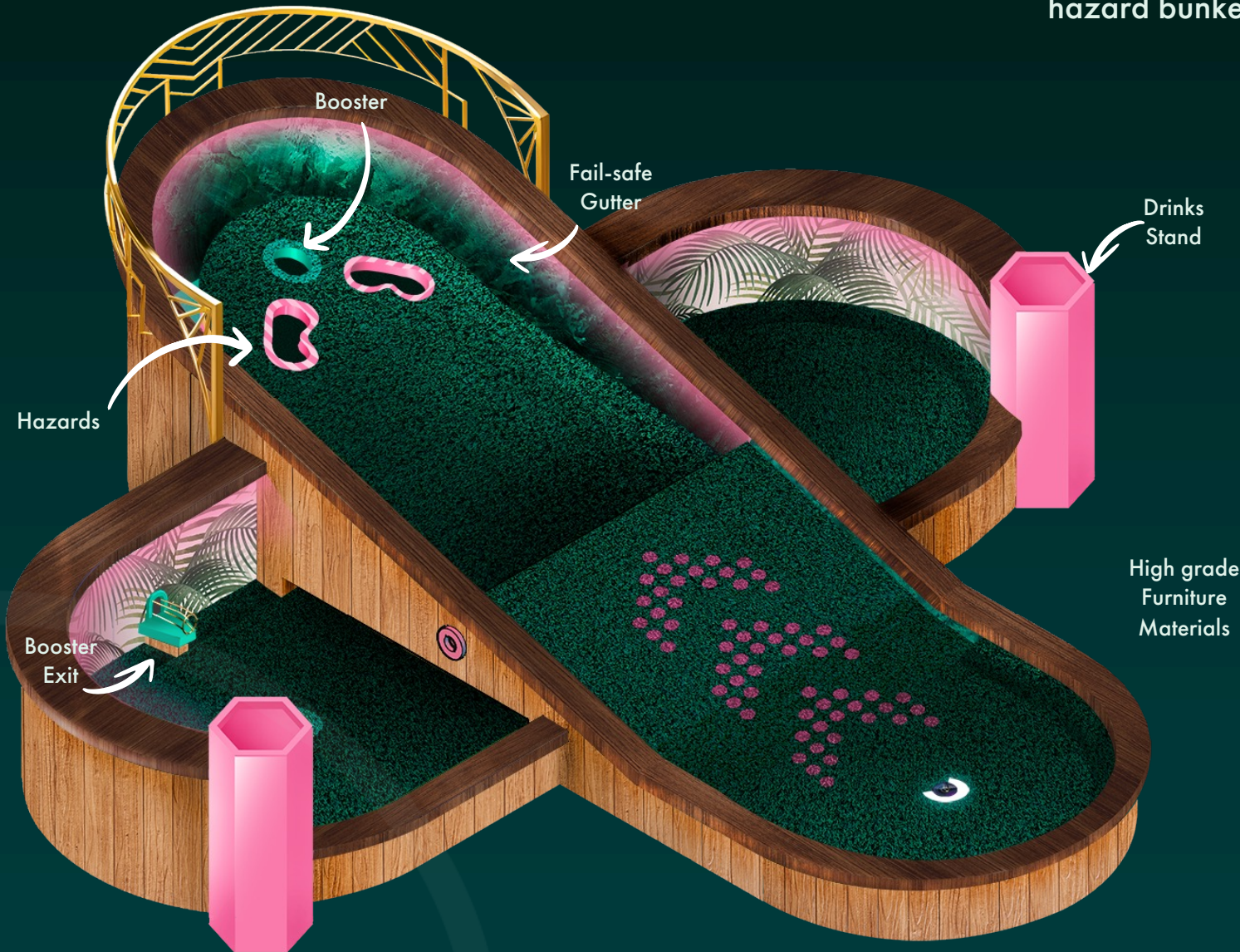

**PAR 3**

Who doesn't love a ride on a Ferris wheel?!

This classic hole design is an old favorite that combines timing and skill with several routes to the hole.

The rotation of the motorized wheel is a great way to add movement to a course's landscape.

# FERRIS WHEEL

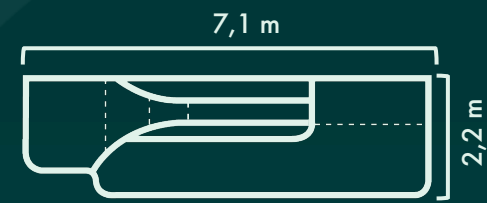
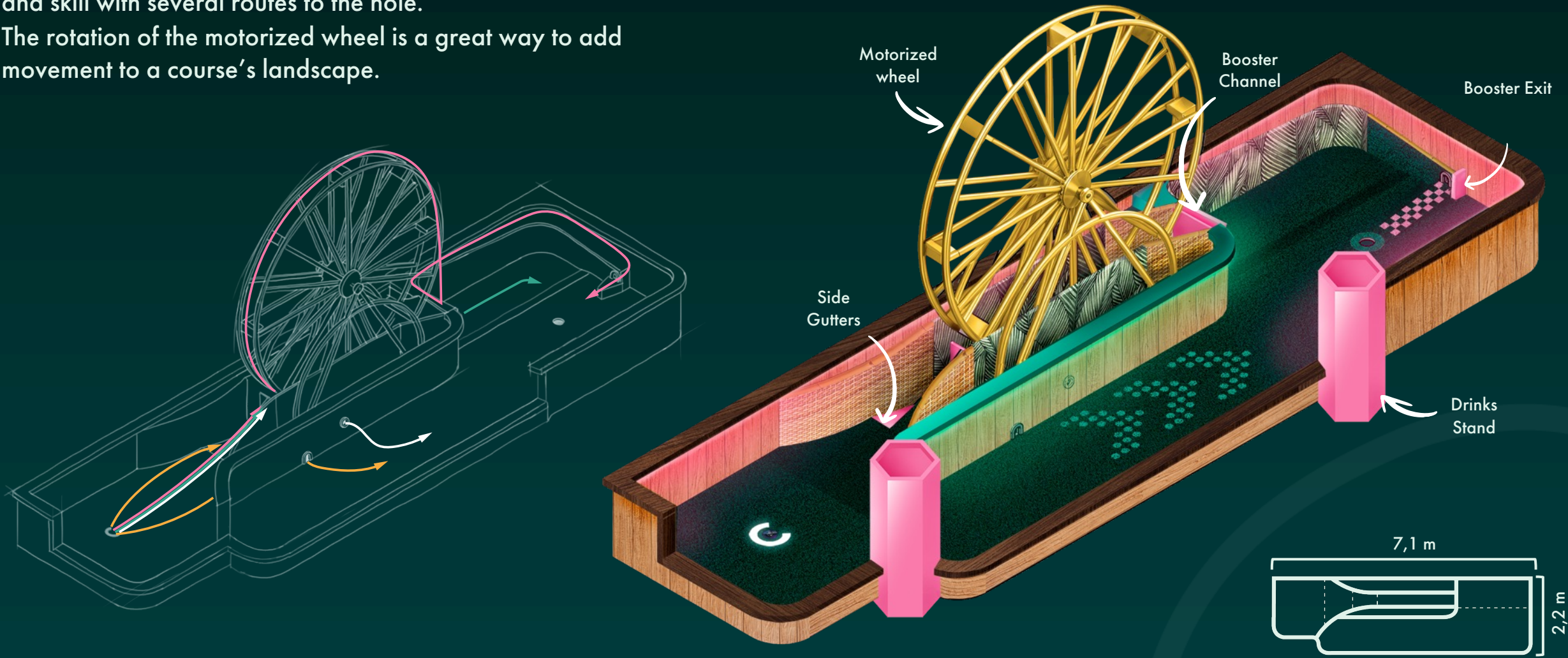

**PAR 4**

# BIG BANK

Simple but elegant, the 'Big Bank' can either be your best friend or your worst enemy, making the strength of your putt key. Combining a faster moving surface with patches of rough turf creates exciting ball motion with the thrill of sinking the Booster at the top of the bank oh-so tempting but, as always, the proximity of the hazards could easily spoil your plan.

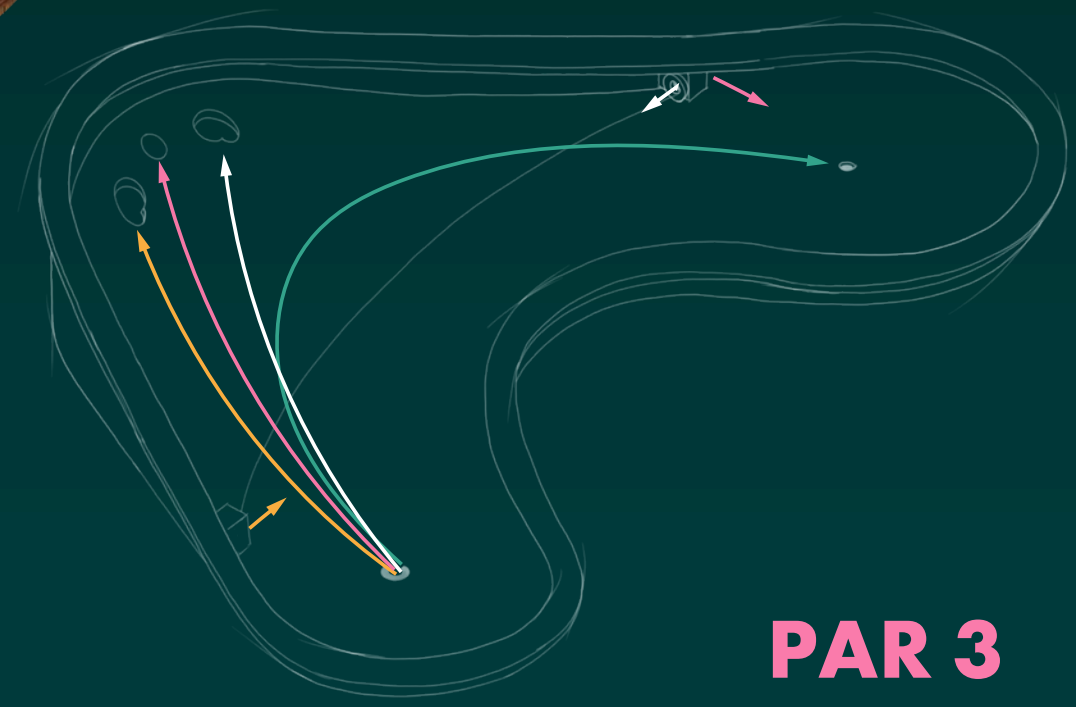
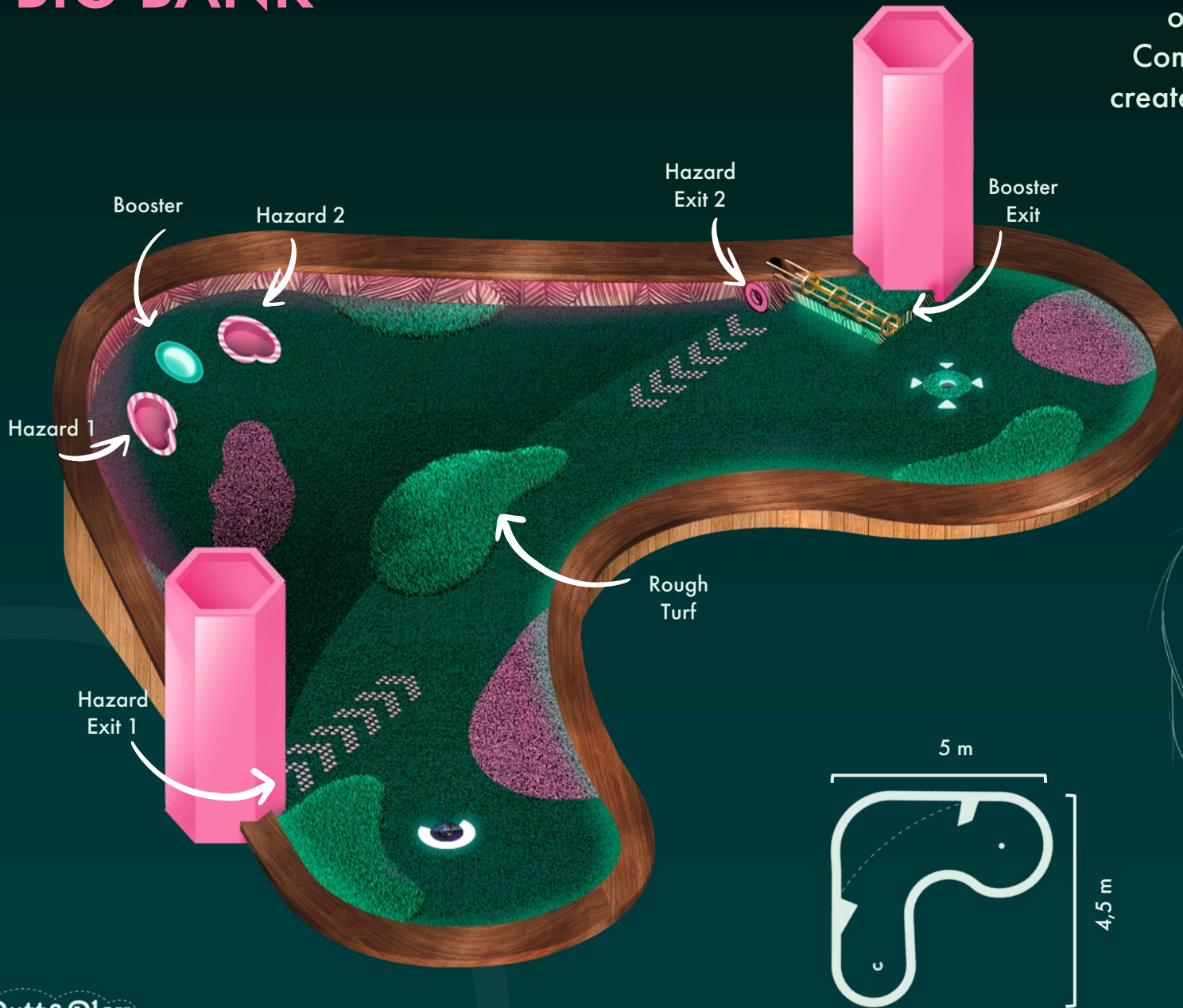

**PAR 3**

# BEVERLY HILLS

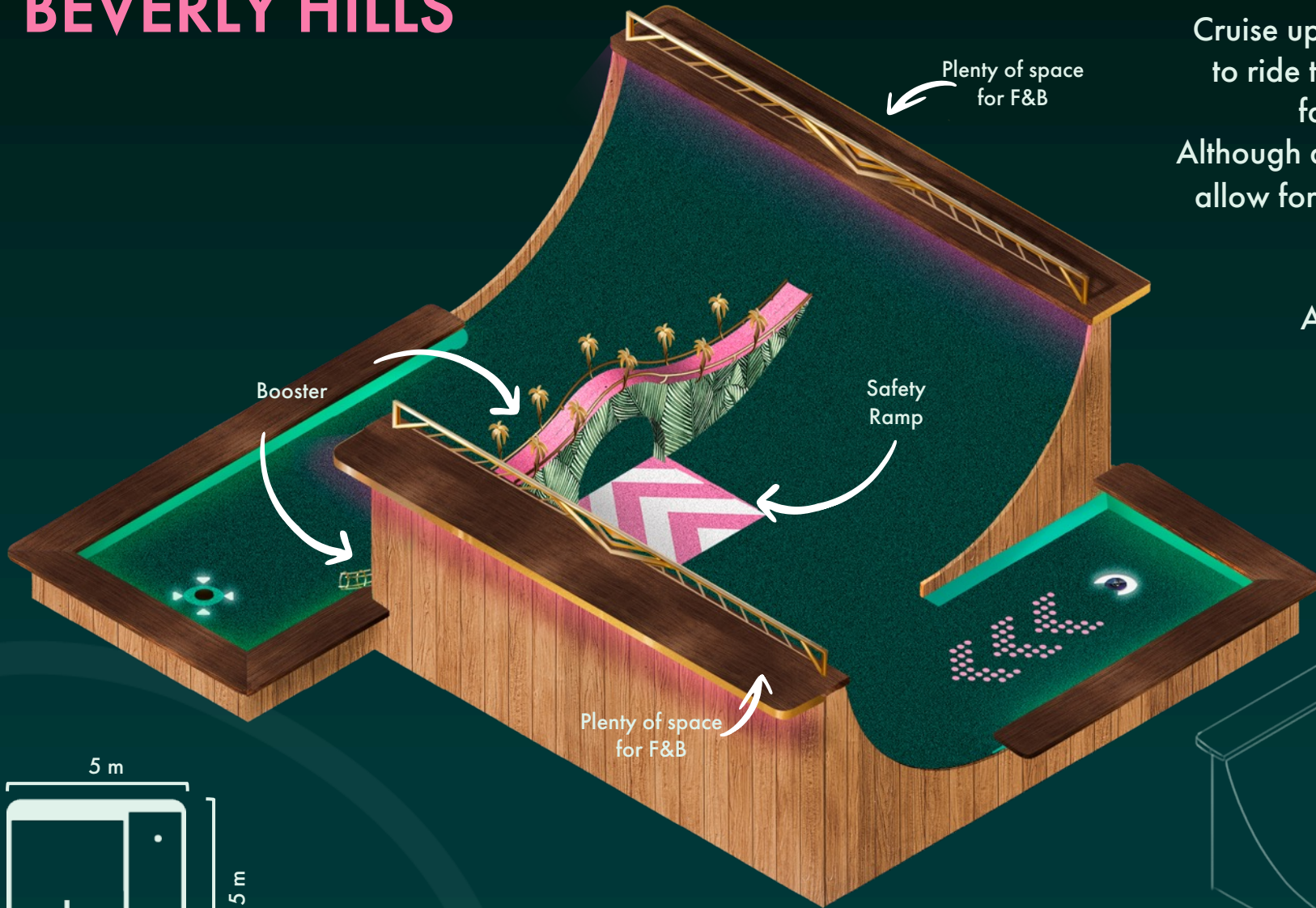

Cruise up and down Beverly Hills and try to get your ball to ride through Sunset Boulevard for a stunning Booster fast-track to get a hole in one & maximum points. Although a simple route to the end, this hole's steep banks allow for a fast & challenging playthrough if your angles aren't just right.

A timid player could opt for a longer way via the underpass just to get a little closer to home.

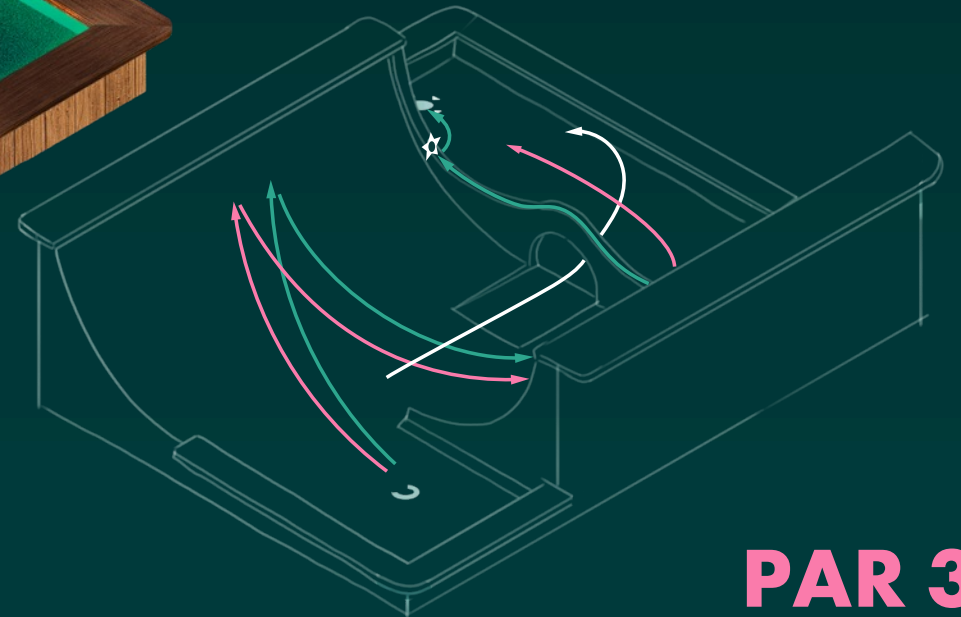
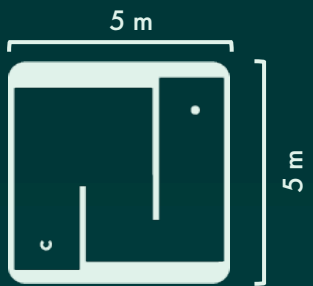

**PAR 3**

# THE WAVE



Ever heard of Turf-Surfing? Well, on 'The Wave' you need to surf your ball up a steep incline and, depending on your angle, have it drop down into the whirlpool. If your angle isn't 'gnarly' enough then your ball will drop into one of 3 gutters, and get spat out a little closer to the final hole... that's if your ball even has the strength to hang-ten and not roll all the way back to the start.

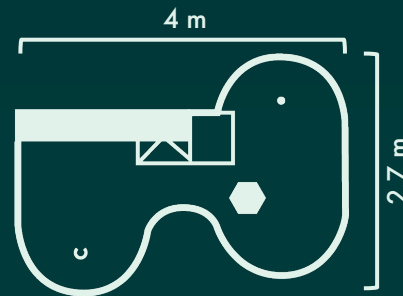
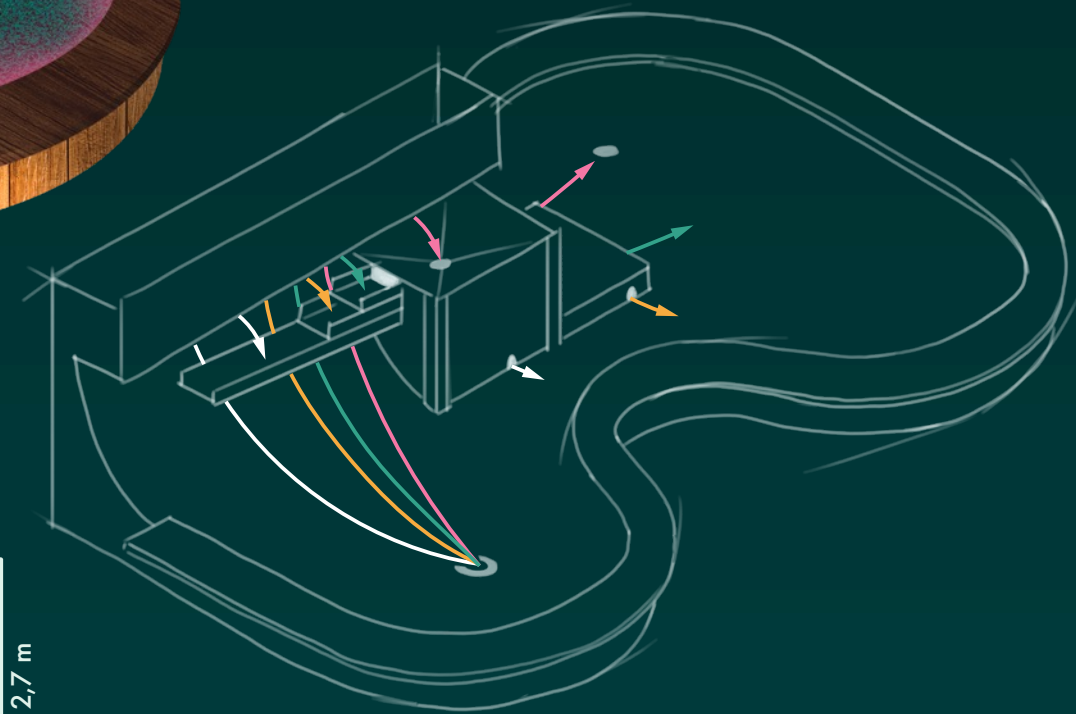

**PAR 4**

# COLUMN

A great hole design for utilizing space effectively at venues where support columns are situated. This loop-D-loop has balls racing around, through the tunnel and hopefully right through the middle of the wedge obstacles below. A Booster tunnel is precariously placed for the more adventurous (or lucky).

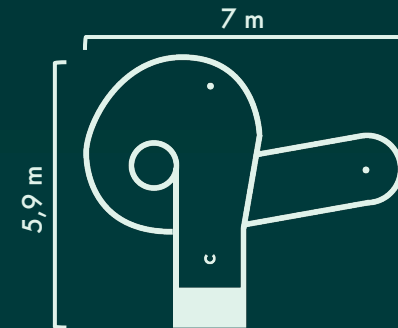
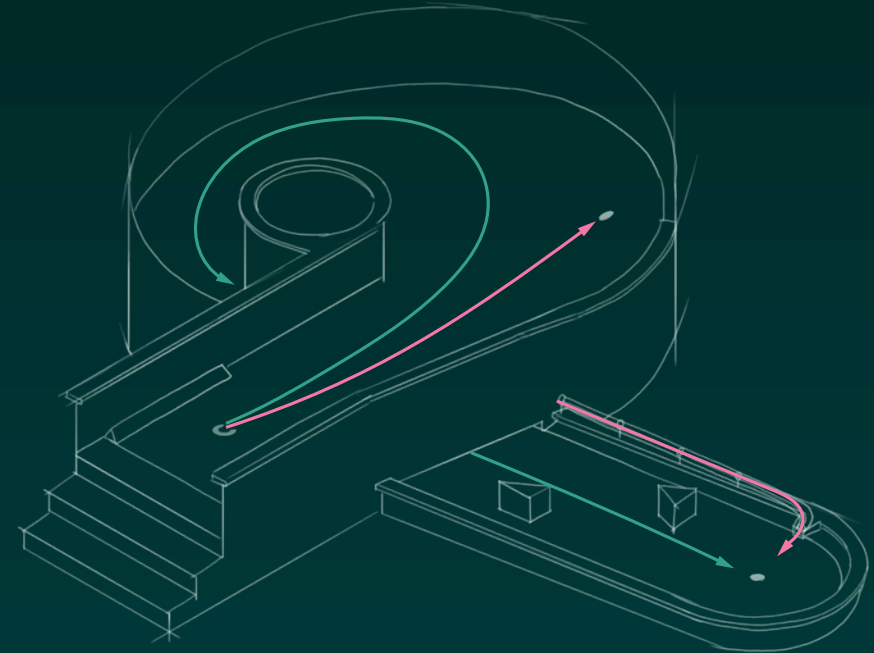
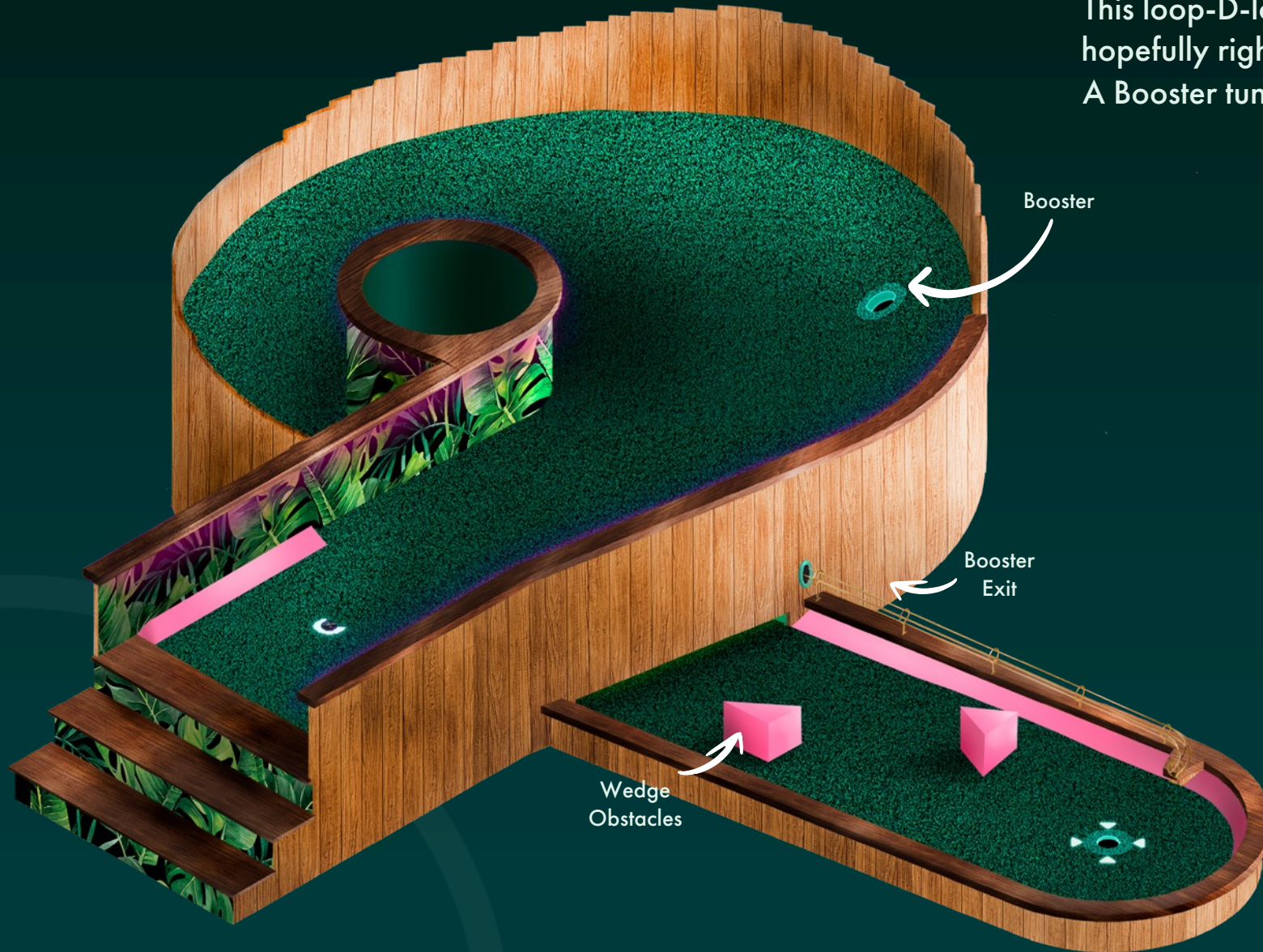

**PAR 3**

# FLORIDA



Chill-out poolside with a cocktail in hand and putt a few balls around the lawn. You can jump the ball over the pool and through the cocktail booster for extra points or use the curved incline to reach the hole. Whatever route you take, try not to make a splash.

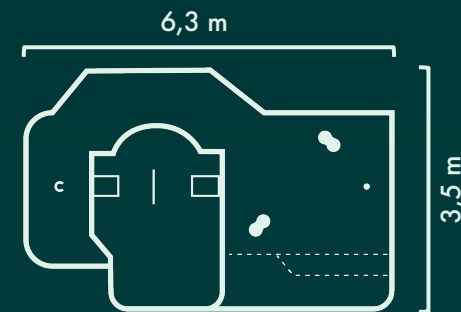
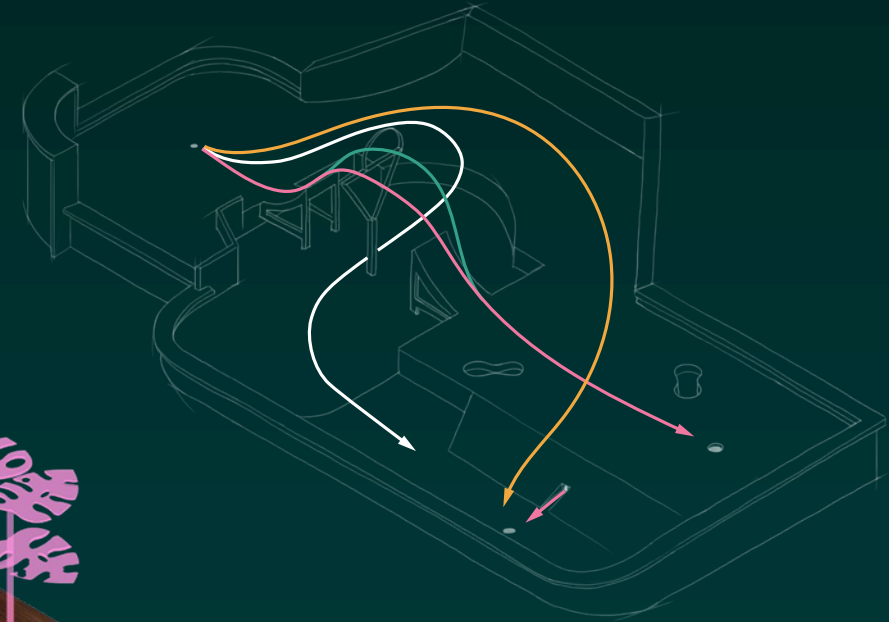

**PAR 3**

# TIGHT-ROPE

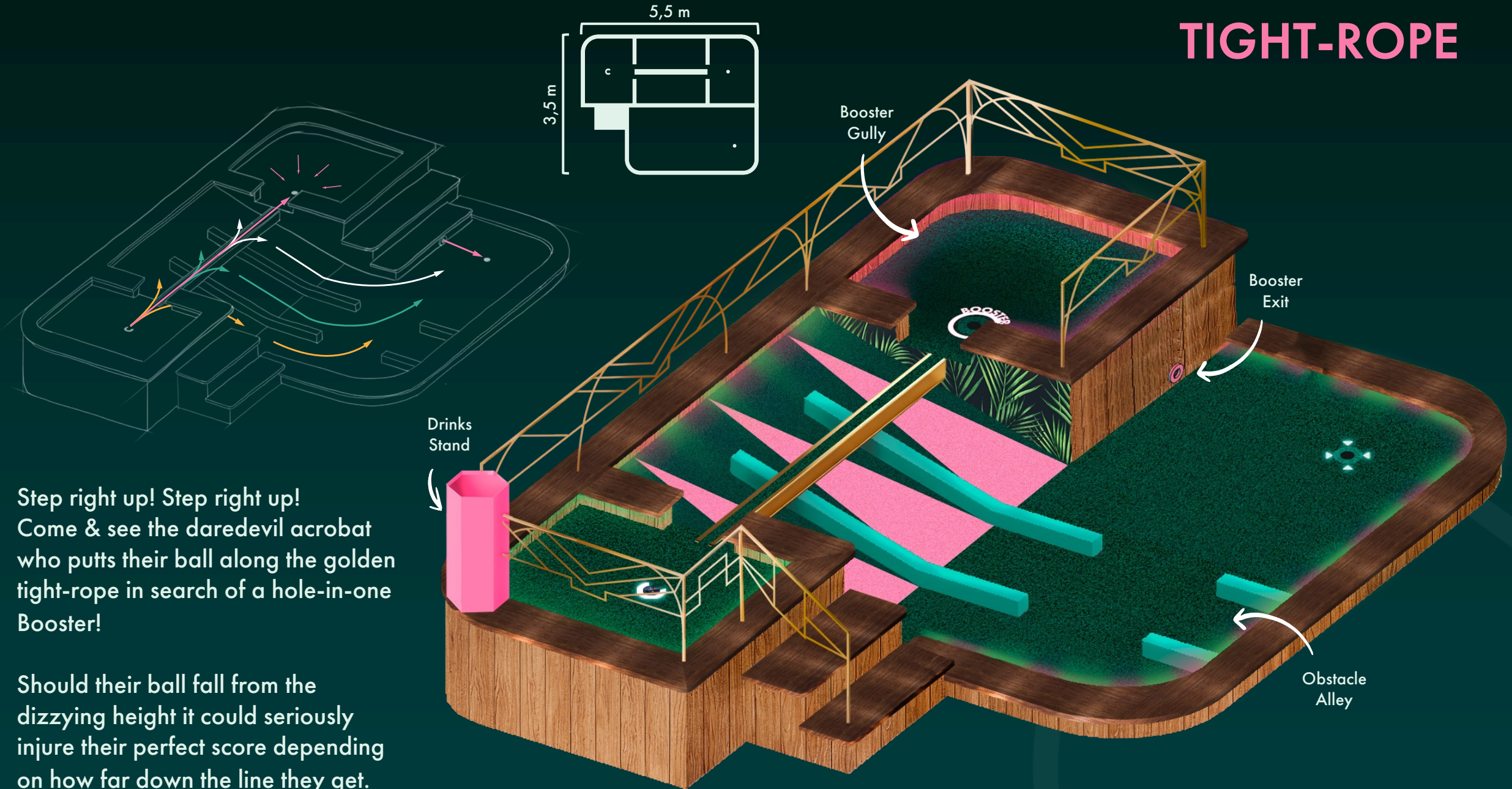

Step right up! Step right up!  
Come & see the daredevil acrobat  
who putts their ball along the golden  
tight-rope in search of a hole-in-one  
Booster!

Should their ball fall from the  
dizzying height it could seriously  
injure their perfect score depending  
on how far down the line they get.

**PAR 4**



# SKEE-BALL

Booster Pocket

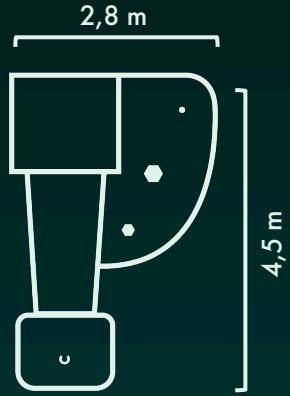

Are you bottom of the leaderboard?  
Well now's your chance to score some serious points!  
This classic carnival game works great for mini golf  
and gives the underdog a fighting chance.

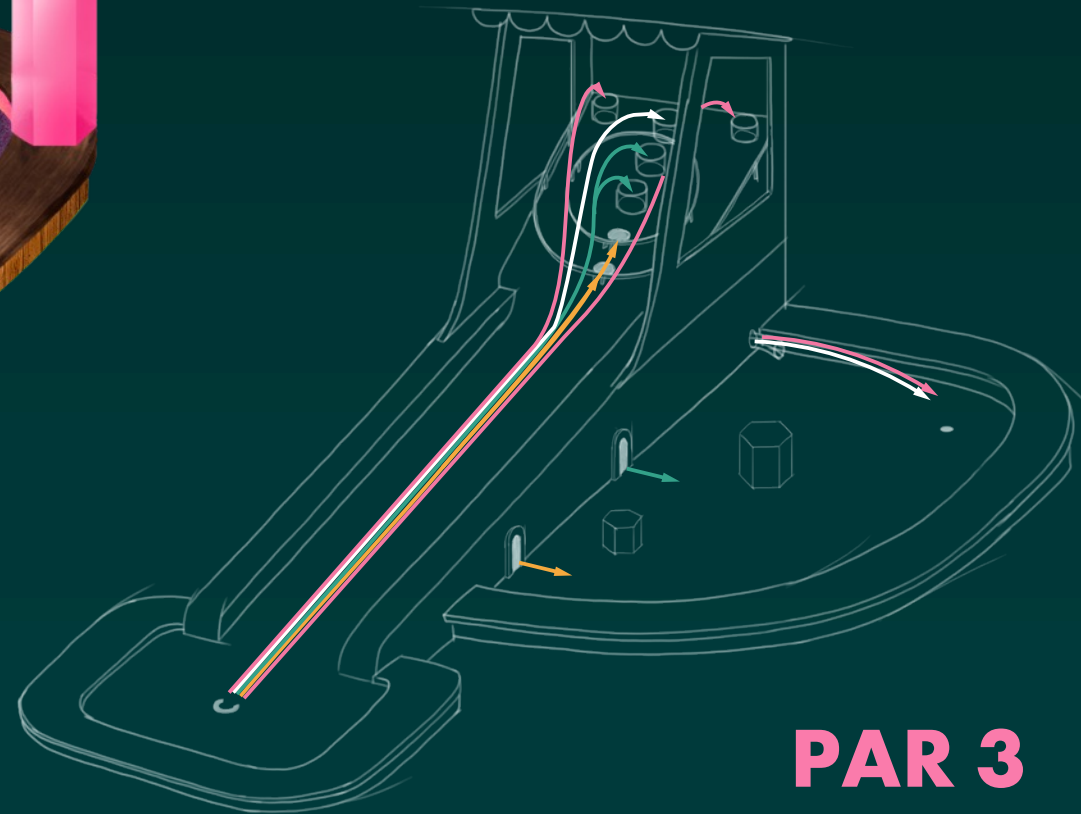

**PAR 3**

The fun and fascination of Rube Goldberg machines have entertained folks for years', so we thought we'd combine it with mini golf and create p'utter madness on the course! Ramp the ball up the steep incline, have it roll across and cascade down the golden putters. If your timing is right (or luck is on your side) then the carousel of cups will ferry your ball to the spiral Booster for a hole-in-one!

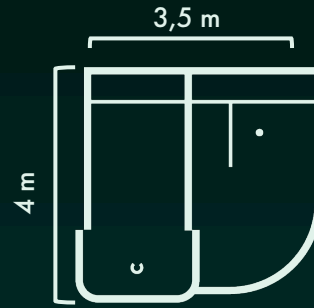

# PUTTER MADNESS

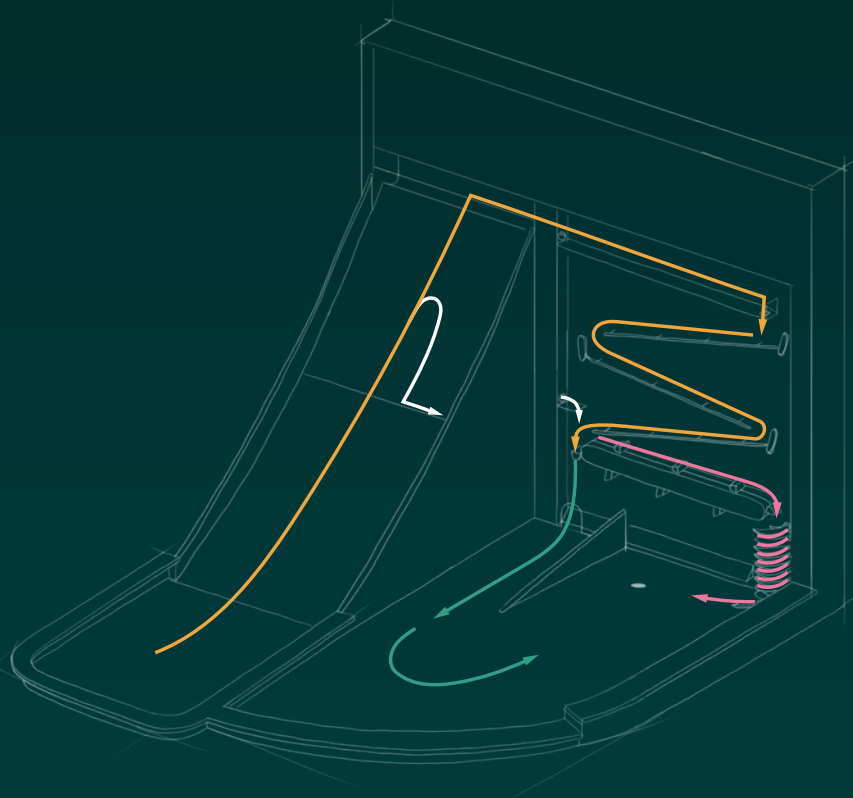

**PAR 3**

# What's Included?

Each delivery includes your selected hole design fabrications, use of our software license and all the required technology (software & hardware) Depending on your requirements you can choose a combination of individual holes for smaller venues or entire multiple hole courses.

## SMALLER VENUES

Booking System



Player Registration  
Ball Scanning

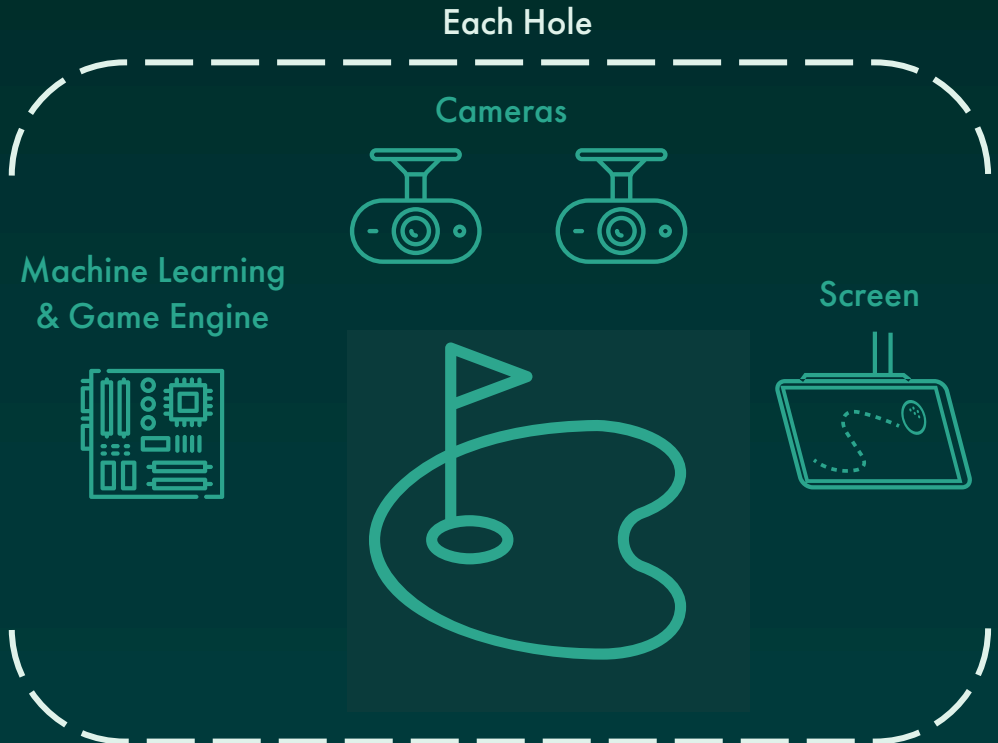
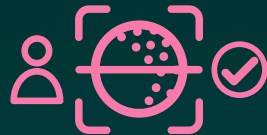

# What's Included?

## LARGER VENUES

Booking System



Check-In Kiosk



Game Notification Board

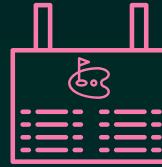

Player Registration Ball Scanning



Multiple Hole Course

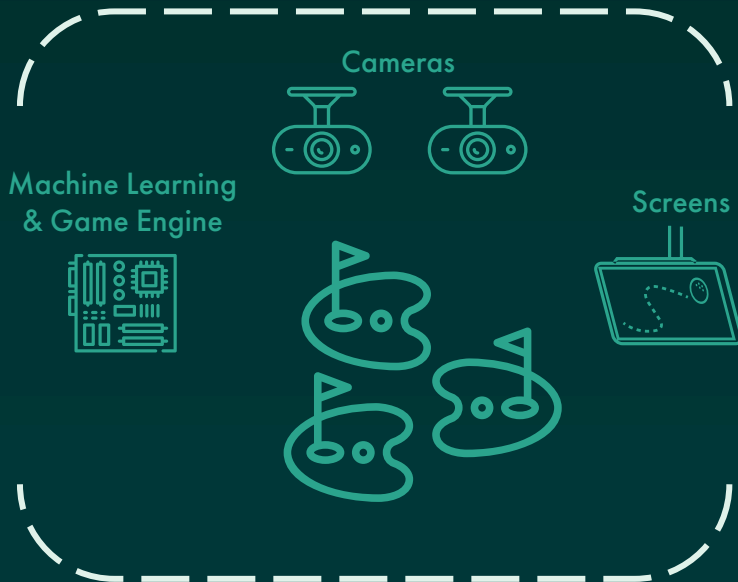

Multiple Hole Course

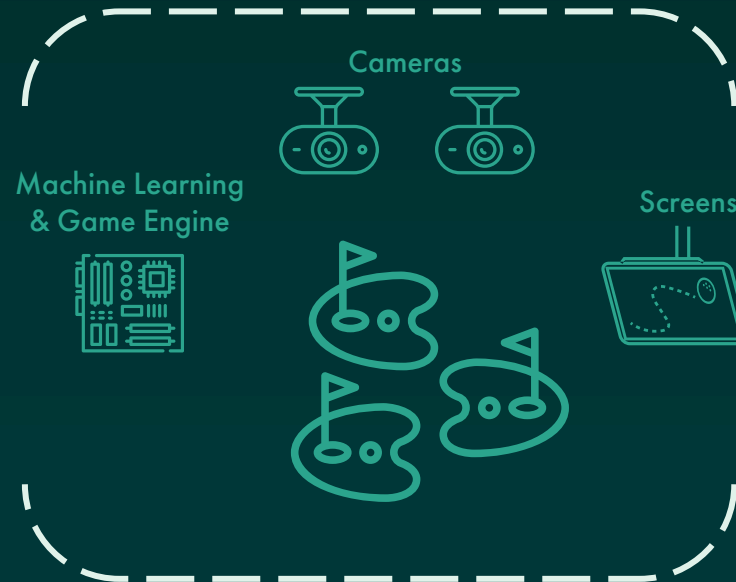

Multiple Hole Course

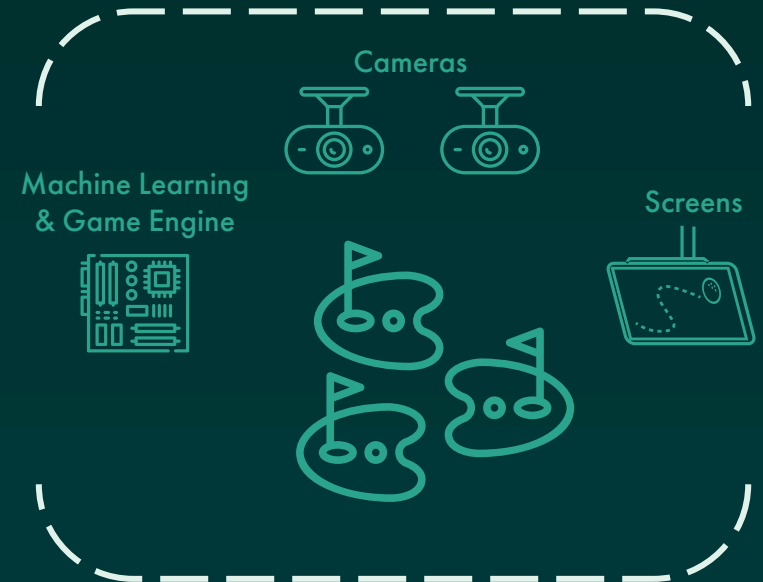

# F&B

Putt & Play synergizes well with food and beverage service by utilizing dormant display screens on empty holes as advertising space for specials and menus. Each hole design also incorporates pedestals and tables so that the festive player's hands are either occupied by a putter or a libation.



**Putt & Play**  
WWW.PUTTNPAY.COM

**2**  
"Four!"  
**1**

**COCKTAIL SPECIAL**

**MENU**

**Putt & Play**  
WWW.PUTTNPAY.COM

**BAR MENU**

**STARTERS**

LOREM IPSUM  
Lorem ipsum dolor sit amet,  
consectetur adipiscing --- \$3.5

LOREM IPSUM  
Lorem ipsum dolor sit amet,  
consectetur adipiscing --- \$3.5

**MAINS**

LOREM IPSUM  
Lorem ipsum dolor sit amet,  
consectetur adipiscing --- \$3.5

LOREM IPSUM  
Lorem ipsum dolor sit amet,  
consectetur adipiscing --- \$3.5

**DRINKS**

LOREM IPSUM  
Lorem ipsum dolor sit amet,  
consectetur adipiscing --- \$3.5

LOREM IPSUM  
Lorem ipsum dolor sit amet,  
consectetur adipiscing --- \$3.5

LOREM IPSUM  
Lorem ipsum dolor sit amet,  
consectetur adipiscing --- \$3.5



# The Putt & Play Social Experience

**HOLE #1**  
PAR 4  
BEST EVER!

**SHOT 2**



**LEADERBOARD**

1. MIAMI	18
2. ANSON	17
3. CASSY	15
4. JIM	14
5. MACHETE POWER	10

Putt & Play

**SHOW EM WHOS BOSS AMY!**

# The Putt & Play Family Experience



HOLE #1	LEADERBOARD
SHOT 2	1. MILO
	2. JENNY
	3. SAM
	4. M. & B. (TWO)

2	1
---	---

HAZARD  
OH NO!  
- 25 P

# Why Putt & Play?



Unique gameplay challenges through state-of-the-art tech, software and gamification



Automated score/shot count: No more uncertainty or blunt pencils



Appeals to audiences both young & old



Increase return visits with fun group dynamics



Modular designs allow for easy site planning & installations, with top quality hole construction using furniture grade wood.



Mix & match different hole design combinations to create your own unique mini golf experience



Ball tracking provides fun gameplay moments and highlight reels for guest take-aways



Convenient course & rate-of-play management



# GET IN TOUCH

Oliver Mahoney

Phone: +44 7590 665485

Email: [ollie@puttnplay.com](mailto:ollie@puttnplay.com)

[www.puttnplay.com](http://www.puttnplay.com)

